

Digital Laser Doppler Vibrometer Vector-Series



HeNe Single-Point Laser Vibrometers

Precise single-point vibrometer in the visible light spectrum. Ideal for all reflecting surfaces, for measurements through water, and for microsystems.

HIGHLIGHTS

- HeNe lasers are able to shine through water with minimal loss of laser power
- Interchangeable lenses available
- Non-contact vibration measurement up to 25 MHz
- Variable working distance from 0mm to > 100m



MULTI-PURPOSE SOLUTION

The Vector Series uses a classic HeNe laser source with a wavelength of 632.8 nm and enables the measurement of vibration between 0 and 25 MHz.

Through the use of different optical systems and decoders for velocity, displacement, or acceleration, the Vector units can be customized for the measurement task at hand. The measuring signals are output in digital form via Ethernet and in analog form via BNC connectors with up to 160 Msamples/s.

Technical Data

Measured Quantities – Performance Parameters

Max. ² Frequency	Max. ² Velocity	Best Vel. ¹ Resolution	Max. ^{2,3} Displacement	Best Disp. ^{1a} Resolution	Max. ^{2,3} Acceleration	Accel. ¹ Resolution
25 MHz	10 m/s	1.3 nm s ⁻¹ /√Hz	±50 mm	0.05 pm /√Hz	32 Mg	1.8μg /√Hz

¹ The Resolution is defined as the signal amplitude (rms) corresponding to a signal-to-noise ratio (SNR) of 0dB with 1 Hz spectral resolution at 50 % f_{max} of smallest measurement range.

^{1a} The Resolution is defined as the signal amplitude (rms) corresponding to a signal-to-noise ratio (SNR) of 0dB with 1 Hz spectral resolution.

² Actual specifications depend on the configured decoder.

³ Optional available

Measurement Specifications

Measured quantities	Velocity, displacement, acceleration
Frequency bandwidth ²	0 Hz - 25 MHz
Max. velocity ²	10 m/s
Velocity measurement ranges ²	14
Signal processing	Digital (FPGA based)
Source impedance	50 Ohm
Analog signal output	3× BNC, ±2 V - Velocity, displacement ³ , acceleration ³ , signal generator ³ - Data rate: 160 MSamples/s @ 16-bit
Digital Signal Output & PC-Interface	1 Gbit RJ45 Ethernet: - Data rate: 1 GBit (53.3 MSamples/s @ 16-bit) - Digital data acquisition- and analysis software <i>OptoGUI</i> - Digital remote control of device settings
External Trigger	Digital external trigger in/out via SMB
Filter	High-pass filter: off / 10 / 20 / 40 / 80 / 160 / 320 / 640 Hz 1.28 / 2.56 / 5 / 10 / 20 / 40 / 80 / 160 kHz (0.16 / 7 / 50 Hz) ⁴ Low-pass filter: off / 2.5 / 5 / 10 / 20 / 50 / 100 kHz Tracking filter: off / slow / fast
Signal delay	The delay of the signal depends on the range and filter settings. Under the determined range and filter settings, the delay of the signal is constant and does not change with changes in the measured signal.

⁴ For Sense Remote decoder

Optical Specifications

Working distances	Variable working distance from 0 mm to >100 m
Laser wavelength	632.8 nm, visible, red laser beam
Laser safety class	Output power: <1 mW, class 2, eye safe
Optics	Auto-, remote-, and manual focussing

General Device Specifications

User interface output	Color screen 3.5" + 20 segment LED bargraph
User interface input	Touch screen, knobs with push-button, key switch (power)
Operating temperature	0 to 40°C
Storage temperature	-10°C to 65°C
Relative Humidity	max. 80%, non-condensing
Dimensions	Length × width × height (excluding handle and lens): 380 × 180 × 148 mm
Weight	8 kg + objective lens
Power supply	100 - 240 V AC (50-60Hz) or 12 V DC
Portable Operation	Possible
Portable power supply	12 V DC portable charger ³
Integrated signal generator ³	- Produce various preset functions (sin, chirp, gaussian, ...) - Import of arbitrary functions and audio wave-files
Calibration interval	Every 12 month (recommended)

Model Options - Decoders^{5,6}

⁵For details see decoder data-sheets. ⁶Variations from displayed models available on request.

Overview Model Options and Characteristics of the default Velocity Decoder⁷

Model (Decoder)	Description	Measuring Ranges ⁵	Max. Velocity	Frequency Bandwidth
Start (D-VD-0)	Entry model	8	2 m/s	0 Hz – 100 kHz
Basis (D-VD-1)	Versatile model with high resolution ⁸	8	2 m/s	0 Hz – 500 kHz
Sense (D-VD-2)	Smallest measurement range ± 1 mm/s and highest resolution ⁹	11	2 m/s	0 Hz – 1 MHz
Sense Remote (D-VD-2-R)	Sense features + extra low Disp.-HPF 0.16 / 7 / 50 Hz	11	2 m/s	0 Hz – 25 kHz
High Speed (D-VD-3)	Supports measurements up to highest velocities	11	10 m/s	0 Hz – 2.5 MHz
High Frequency (D-VD-4)	Supports measurements up to highest frequencies	9	5 m/s	0 Hz – 10 MHz
Master (D-VD-5)	The all-rounder: Includes all Sense, High Speed, and High Frequency features	14	10 m/s	0 Hz – 10 MHz
Master+ (D-VD-5-25)	Includes all Master features and has an additional super-high frequency upgrade	14	10 m/s	0 Hz – 25 MHz ¹⁰

⁷ All models feature by default a velocity decoder and optionally displacement and acceleration decoders

⁸ Best velocity res.: $6 \text{ nm s}^{-1}/\sqrt{\text{Hz}}$.

⁹ Best velocity res.: $1.3 \text{ nm s}^{-1}/\sqrt{\text{Hz}}$.

¹⁰ Velocity limited to 0.5 m/s at frequencies above 10 MHz.

Characteristics of the optional Displacement Decoder⁷

Decoder	Required Vel-Decoder	Number Measuring Ranges ⁵	Smallest Range ¹¹	Largest Range	Frequency Bandwidth
D-DD-0	D-VD-0	19	± 50 nm	± 50 mm	0 Hz – 100 kHz
D-DD-1	D-VD-1	19	± 50 nm	± 50 mm	0 Hz – 500 kHz
D-DD-2	D-VD-2	19	± 50 nm	± 50 mm	0 Hz – 1 MHz
D-DD-2-R	D-VD-2-R	19	± 50 nm	± 50 mm	0 Hz – 25 kHz
D-DD-3	D-VD-3	19	± 50 nm	± 50 mm	0 Hz – 2.5 MHz
D-DD-4	D-VD-4	19	± 50 nm	± 50 mm	0 Hz – 10 MHz
D-DD-5	D-VD-5	19	± 50 nm	± 50 mm	0 Hz – 10 MHz
D-DD-5-25	D-VD-5-25	19	± 50 nm	± 50 mm	0 Hz – 25 MHz ¹⁰

Characteristics of the optional Acceleration Decoder⁷

Decoder	Required Vel-Decoder	Number Measuring Ranges ⁵	Smallest Range ¹²	Largest Range	Frequency Bandwidth
D-AD-0	D-VD-0	8	± 160 g	± 0.128 Mg	0 Hz – 100 kHz
D-AD-1	D-VD-1	8	± 160 g	± 0.64 Mg	0 Hz – 500 kHz
D-AD-2	D-VD-2	11	± 1.6 g	± 1.280Mg	0 Hz – 1 MHz
D-AD-2-R	D-VD-2-R	11	± 1.6 g	± 0.032Mg	0 Hz – 25 kHz
D-AD-3	D-VD-3	11	± 160 g	± 16 Mg	0 Hz – 2.5 MHz
D-AD-4	D-VD-4	9	± 160 g	± 32 Mg	0 Hz – 10 MHz
D-AD-5	D-VD-5	14	± 1.6 g	± 32 Mg	0 Hz – 10 MHz
D-AD-5-25	D-VD-5-25	14	± 1.6 g	± 32 Mg	0 Hz – 25 MHz ¹³

¹¹ Best displacement resolution: 0.05 pm.

¹² Best acceleration resolution: 1.8µg /√Hz.

¹³ Acceleration limited to 7.68 Mg at frequencies above 10 MHz.

Set-up: Objective lens with Vibrometer

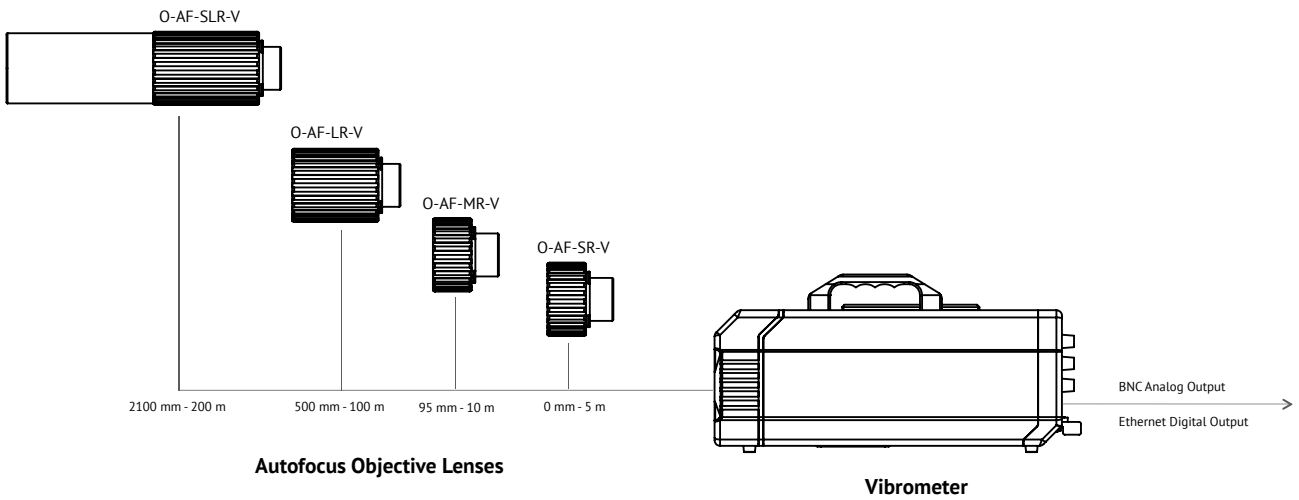

Objective lens

Specification	Short-Range Autofocus	Mid-Range Autofocus	Long-Range Autofocus	Super-Long Range Autofocus
Focal length (mm)	25	50	100	200
Min. stand-off distance (mm)*	0	95	500	2100
Min. Spot size in μm	6	10	30	126
Working distance*	0 mm ... 5 m	95 mm ... 10 m	500 mm ... 100 m	2.1 m ... 200 m

* Measured from the front of the objective lens

Dimension of the Vibrometer

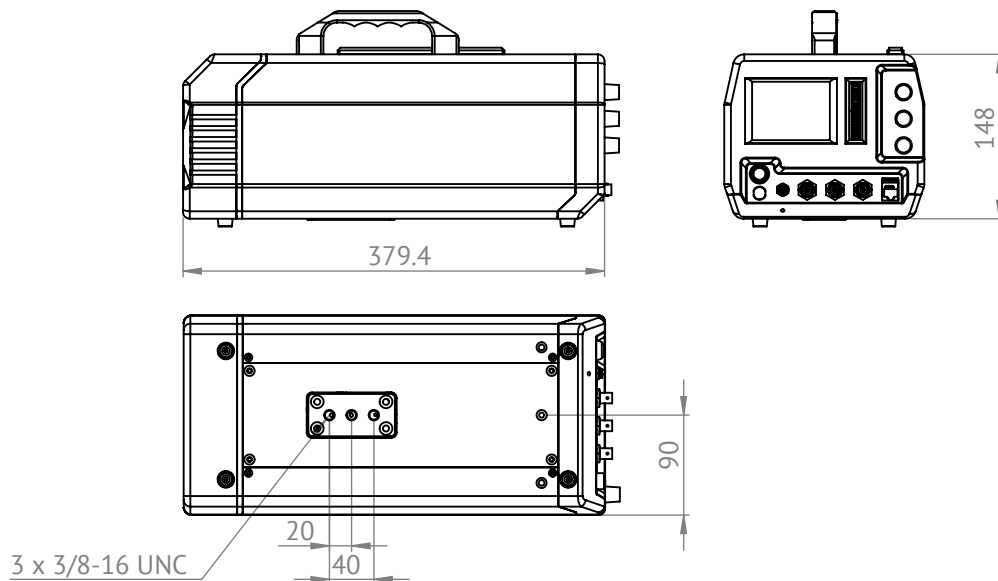

Set-up: Micro Optics with Vibrometer

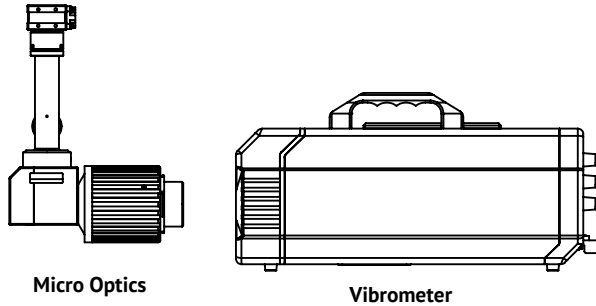

Specifications





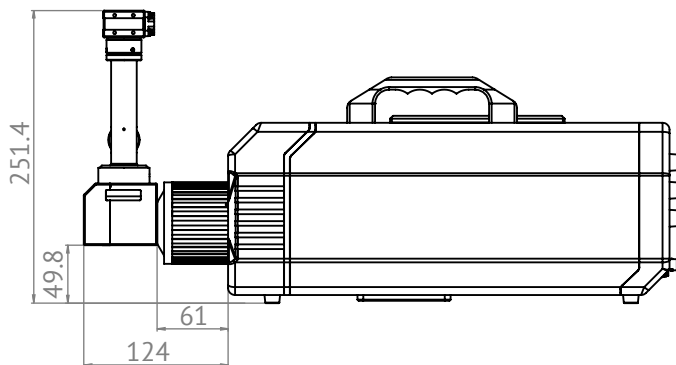

Laser wavelength	632.8 nm, visible, red laser beam
Camera Type	1/1.7" CMOS
Camera active pixels	4000 x 3000 pixel
Camera output	12MP or 4K
Camera PC Interface	USB 3.1
Telecentric lens	Coaxial telecentric lens with illumination
Working distance	21 mm
Laser Spot size	3.0 μm
Laser depth of field	0.022 mm
Camera field of view	1.25 x 1.00 mm
Contrast adjustment	Built-in filter for adjusting the brightness of the laser spot in the video stream (manually adjustable by the user)
Connection	Using Bayonet mount to connect with vibrometer, Interchangeable with standard objective lenses (refer to page 5)

Dimension of the Micro Optics



Accessories

^S Standard included, ^O Optional available

	<p>Transport Case for Single Point Vibrometer Stable and waterproof <i>Peli</i> case for safe keeping and transport of vibrometer. External dimension (L x B x H): 61.9 x 49.2 x 22.3 cm</p>	S
	<p>Transport Bag Compact und light transport bag for outdoor measurements or transport as carry-on baggage in an plane.</p>	O
	<p>Telescope For measurements from a greater distance, a telescope makes it easier to find the measuring point. The telescope can be easily mounted on the gauge rail at the top of the vibrometer.</p>	O
	<p>Mobile Battery Portable battery charger, external battery power bank. For powering the vibrometer when performing outdoor measurements.</p>	O
	<p>Tripod with Fluid Head Precisely align your vibrometer with high quality tripods by <i>Manfrotto</i>.</p>	O
	<p>Positioning Stage Precisely align your Micro Optics system in three axes x, y, z Motion adjustment range of positioning stage: +12,5mm (x, y) and +10mm (z)</p>	O
	<p>Transport Case for Micro Optics Safely store your Micro Optics in a high quality <i>Peli</i> case</p>	S

Software

	<p>OptoGUI Analysis Software Software for data acquisition, analysis and remote control. Live animation of measured time and frequency data.</p>	O
---	---	---



OptoGUI software includes

Remote control	Remotely control all vibrometer settings via ethernet.	S
Read-out	Read out data via ethernet with up to 80 MS/s	S
Time data	Live animation of measured vel./disp./accel. data	S
Export data	Export time data as .csv, .h5, .wav or .mat files	S
Fourier-Transformation	-Real-Time Fast Fourier Transformation -up to 536 Mio. FFT lines	S
Peak identification	Automatically identify signal peaks in the frequency spectrum	S
Spectrogram	Show a live Spectrogram of the FFTs of the ongoing measurements	S
Fourier boundaries	Limit live FFT-calculation to certain time ranges of the time data	S
Signal trigger	Trigger your measurement with the vel., disp., or accel. signal	S
External trigger	Trigger your measurement with an external TTL signal (3.3 V)	O
Multiple traces	Record and recall multiple traces of the vel./disp./accel. time data	S
Arbitrary signal generator	Import file formats: .csv ASCII- or .wav audio files Pre-defined signals: sin, rectangle, chirp, random, ...	O

Maintenance Specials

Warranty

Warranty	12 months	S
Warranty extension	Extension of standard warranty to 24 months	O

Software Updates

Software maintenance	Free software updates within warranty period	S
Extended maintenance	Additional extension of software updates by 12+ months	O

Hardware Maintenance

Hardware Maintenance	Free hardware maintenance within warranty period	S
Extended maintenance	Additional extension of hardware maintenance by 12+ months	O
Recalibration & cleaning	Check, cleaning & realignment of optical parts, check of laser output power, perform factory calibration	O

Laser product label

DO NOT STARE INTO BEAM Class 2 Laser Product
Laser CLASS 2: visible, red laser beam, $\lambda = 632.8 \text{ nm}$,
output power: $\leq 1 \text{ mW}$



optomet.

LASER VIBROMETRY



Optomet GmbH

Pfungstädter Straße 92
64297 Darmstadt
Germany

Phone: +49 6151-38432-0
Mail: sales@optomet.de
www.optomet.com

