



Digital Laser Doppler Vibrometer Nova-Xtra



Nova-Xtra: Detect distant vibrations up to 300 m with our precision-enhancing Extra-Large-Lens system!

The Optomet Nova-Xtra is an extension of the Nova series and enables vibration measurements on distant objects with an extra-long range up to 300 m.



IDEAL FOR

- Bridges, pipelines and other structures
- High Buildings
- Dark / rough surfaces
- Moving or rotating objects, e.g., wind turbines
- Restricted and inaccessible areas
- Measurement on any material, e.g., concrete, metal

Long distance measurements

Enhanced by the powerful yet discreet SWIR laser, the Nova-Xtra guarantees exceptional signal strength, ensuring optimal performance even in challenging conditions. This remarkable feature makes it the ultimate tool for professionals in civil engineering and the aerospace industry, who demand accuracy and reliability in their measurements.

For added convenience and versatility, the Nova-Xtra offers an optional IR camera. This additional feature allows you to visualize and precisely locate the laser spot on the object of interest, further enhancing your workflow and facilitating precise measurements.

Technical Data

Measured Quantities – Performance Parameters

Max. ² Frequency	Max. ² Velocity	Best Vel. ¹ Resolution	Max. ^{2,3} Displacement	Best Disp. ^{1a} Resolution	Max. ^{2,3} Acceleration	Best Accel. ¹ Resolution
25 MHz	30 m/s	1.7 nm s ⁻¹ /√Hz	±1.225 m	0.05 pm /√Hz	78.4 Mg	1.8μg /√Hz

¹ The Resolution is defined as the signal amplitude (rms) corresponding to a signal-to-noise ratio (SNR) of 0dB with 1 Hz spectral resolution at 50 % f_{max} of smallest measurement range.

^{1a} The Resolution is defined as the signal amplitude (rms) corresponding to a signal-to-noise ratio (SNR) of 0dB with 1 Hz spectral resolution.

² Actual specifications depend on the configured decoder.

³ Optional available

Measurement Specifications

Measured quantities	Velocity, displacement, acceleration
Frequency bandwidth ²	0 Hz - 25 MHz
Max. velocity ²	30 m/s
Velocity measurement ranges ²	15
Signal processing	Digital (FPGA based)
Source impedance	50 Ohm
Analog signal output	3 × BNC, ±2 V - Velocity, displacement ³ , acceleration ³ , signal generator ³ - Data rate: 160 MSamples/s @ 16-bit
Digital Signal Output & PC-Interface	1 Gbit RJ45 Ethernet: - Data rate: 1 GBit (53.3 MSamples/s @ 16-bit) - Digital data acquisition- and analysis software <i>OptoGUI</i> - Digital remote control of device settings
External Trigger	Digital external trigger in/out via SMB
Filter	High-pass filter: off / 10 / 20 / 40 / 80 / 160 / 320 / 640 Hz 1.28 / 2.56 / 5 / 10 / 20 / 40 / 80 / 160 kHz (0.16 / 7 / 50 Hz) ⁴ Low-pass filter: off / 2.5 / 5 / 10 / 20 / 50 / 100 kHz Tracking filter: off / slow / fast

⁴ For Sense Remote decoder

Optical Specifications

Working distances	Variable working distance from 6 mm to >300 m
Laser wavelength	Measurement laser: 1550 nm, Target laser: 510-530 nm
Laser safety class	Measurement laser: output power: <10 mW, class 1 Target laser: output power: <1 mW, class 2
Optics	Auto-, remote-, and manual focussing

³ Optional available

General Device Specifications

User interface output	Color screen 3.5" + 20 segment LED bargraph
User interface input	Touch screen, knobs with push-button, key switch (power)
Operating temperature	0 to 40°C
Storage temperature	-10°C to 65°C
Relative Humidity	max. 80%, non-condensing
Dimensions	Length × width × height (excluding handle and lens): 380 × 180 × 148 mm
Weight	8 kg + objective lens
Power supply	110 - 240 V AC (50-60Hz) or 12 V DC
Portable Operation	Possible
Portable power supply	12 V DC portable charger ³
Integrated signal generator ³	- Produce various preset functions (sin, chirp, gaussian, ...) - Import of arbitrary functions and audio wave-files
Calibration interval	Every 12 month (recommended)

Model Options - Decoders^{5,6}

⁵For details see decoder data-sheets. ⁶Variations from displayed models available on request.

Overview Model Options and Characteristics of the default Velocity Decoder⁷

Model (Decoder)	Description	Measuring Ranges ⁵	Max. Velocity	Frequency Bandwidth
Start (D-VD-0N)	Entry model.	7	2.5 m/s	0 Hz – 100 kHz
Basis (D-VD-1N)	Versatile model with high resolution ⁸	8	5 m/s	0 Hz – 500 kHz
Sense (D-VD-2N)	Smallest measurement range ± 2.45 mm/s and highest resolution ⁹	11	5 m/s	0 Hz – 1 MHz
Sense Remote (D-VD-2N-R)	Sense features + extra low disp.-HPF 0.16 / 7 / 50 Hz (measure building vibrations, etc.).	11	5 m/s	0 Hz – 25 kHz
Sense Speed (D-VD-2N-12)	Sense features + additional measurement range at ± 12 m/s.	12	12 m/s	0 Hz – 1 MHz
High Speed (D-VD-3N)	Supports measurements up to highest velocities.	11	25 m/s	0 Hz – 2.5 MHz
Ultra High Speed (D-VD-3N-30)	Supports measurements up to highest velocities.	12	30 m/s	0 Hz – 2.5 MHz
High Frequency (D-VD-4N)	Supports measurements up to highest frequencies.	9	12 m/s	0 Hz – 10 MHz
Master (D-VD-5N)	The all-rounder: Includes all Sense, High Speed, and High Frequency features.	14	25 m/s	0 Hz – 10 MHz
Master+ (D-VD-5N-25)	Includes all Master features and has an additional super-high frequency upgrade	14	25 m/s	0 Hz – 25 MHz ¹⁰
Master++ (D-VD-5N-30)	Includes all Master features and has an additional super-high frequency upgrade	15	30 m/s ^{10a}	0 Hz – 25 MHz ¹⁰

⁷ All models feature by default a velocity decoder and optionally displacement and acceleration decoders

⁸ Best velocity res.: 12 nm s⁻¹ / √Hz

⁹ Best velocity res.: 1.7 nm s⁻¹ / √Hz

¹⁰ Velocity limited to 1 m/s at frequencies above 10 MHz

^{10a} Frequency limited to 100 kHz at velocity 30 m/s

Characteristics of the optional Displacement Decoder⁷

Decoder	Required Vel-Decoder	Number Measuring Ranges ⁵	Smallest Range ¹¹	Largest Range	Frequency Bandwidth
D-DD-0N	D-VD-0N	19	±122.5 nm	±122.5 mm	0 Hz – 100 kHz
D-DD-1N	D-VD-1N	19	±122.5 nm	±122.5 mm	0 Hz – 500 kHz
D-DD-2N	D-VD-2N	19	±122.5 nm	±122.5 mm	0 Hz – 1 MHz
D-DD-2N-R	D-VD-2N-R	19	±122.5 nm	±1.225 m	0 Hz – 25 kHz
D-DD-2N-12	D-VD-2N-12	19	±122.5 nm	±122.5 mm	0 Hz – 1 MHz
D-DD-3N	D-VD-3N	19	±122.5 nm	±122.5 mm	0 Hz – 2.5 MHz
D-DD-3N-30	D-VD-3N-30	19	±122.5 nm	±122.5 mm	0 Hz – 2.5 MHz
D-DD-4N	D-VD-4N	19	±122.5 nm	±122.5 mm	0 Hz – 10 MHz
D-DD-5N	D-VD-5N	19	±122.5 nm	±122.5 mm	0 Hz – 10 MHz
D-DD-5N-25	D-VD-5N-25	19	±122.5 nm	±122.5 mm	0 Hz – 25 MHz ¹⁰
D-DD-5N-30	D-VD-5N-30	19	±122.5 nm	±122.5 mm	0 Hz – 25 MHz ¹⁰

¹¹ Best displacement resolution: 0.05 µm.

Characteristics of the optional Acceleration Decoder⁷

Decoder	Required Vel-Decoder	Number Measuring Ranges ⁵	Smallest Range ¹²	Largest Range	Frequency Bandwidth
D-AD-0N	D-VD-0N	7	±392 g	±0.16 Mg	0 Hz – 100 kHz
D-AD-1N	D-VD-1N	8	±392 g	±1.6 Mg	0 Hz – 500 kHz
D-AD-2N	D-VD-2N	11	±3.9 g	±3.2 Mg	0 Hz – 1 MHz
D-AD-2N-R	D-VD-2N-R	11	±3.9 g	±80 kg	0 Hz – 25 kHz
D-AD-2N-12	D-VD-2N-12	12	±3.9 g	±7.6 Mg	0 Hz – 1 MHz
D-AD-3N	D-VD-3N	11	±392 g	±39.2 Mg	0 Hz – 2.5 MHz
D-AD-3N-30	D-VD-3N-30	12	±392 g	±39.2 Mg	0 Hz – 2.5 MHz
D-AD-4N	D-VD-4N	9	±392 g	±76.8 Mg	0 Hz – 10 MHz
D-AD-5N	D-VD-5N	14	±3.9 g	±78.4 Mg	0 Hz – 10 MHz
D-AD-5N-25	D-VD-5N-25	14	±3.9 g	±78.4 Mg	0 Hz – 25 MHz ¹³
D-AD-5N-30	D-VD-5N-30	15	±3.9 g	±78.4 Mg	0 Hz – 25 MHz ¹³

¹² Best acceleration resolution: 1.8 µg / √Hz.

¹³ Acceleration limited to 15.3 Mg at frequencies above 10 MHz.

Objective lens for Extra-Long distance (O-AF-XLR-N)







Stand-off distance ¹⁴ (m)	Laser spot diameter (μm)	Depth-of-field (mm)
2.49	170	± 15
3.79	240	± 29
6.48	440	± 98
10.2	480	± 117
20.5	970	± 477
48.5	2600	± 3425
With each additional meter plus [μm]	+ 55	-



¹⁴ Measured from the front of the objective lens

Accessories

^S Standard included, ^O Optional available

	<p>Transport Case for Single Point Vibrometer Stable and waterproof <i>Peli</i> case for safe keeping and transport of vibrometer. External dimension (L x B x H): 61.9 x 49.2 x 22.3 cm</p>	S
	<p>Transport Bag Compact und light transport bag for outdoor measurements or transport as carry-on baggage in an plane.</p>	O
	<p>Telescope For measurements from a greater distance, a telescope makes it easier to find the measuring point. The telescope can be easily mounted on the gauge rail at the top of the vibrometer.</p>	O
	<p>IR-Camera For digital visualizing of the laser point. The camera can be easily mounted on the gauge rail at the top of the vibrometer.</p>	O
	<p>IR-Detector Card Transforming the not-visible infrared light into a spot of visible light.</p>	S
	<p>Mobile Battery¹⁵ Portable battery charger, external battery power bank. For powering the vibrometer when performing outdoor measurements.</p>	O
	<p>Tripod with Fluid Head Precisely align your vibrometer with high quality tripods by <i>Manfrotto</i>.</p>	O

¹⁵Adapter cable for different recommended battery models available

Dimension of the Vibrometer

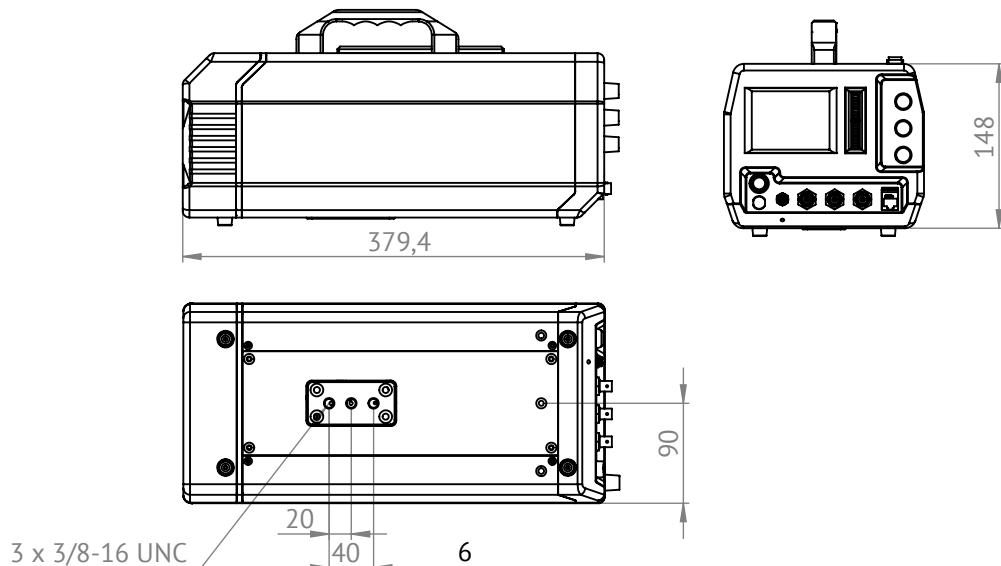



Software



OptoGUI Analysis Software

Software for data acquisition, analysis and remote control. Live animation of measured time and frequency data.

0

OptoGUI software includes

Remote control	Remotely control all vibrometer settings via ethernet.	S
Read-out	Read out data via ethernet with up to 80 MS/s	S
Time data	Live animation of measured vel. /disp. /accel. data	S
Export data	Export time data as .csv, .h5, .wav or .mat files	S
Fourier-Transformation	-Real-Time Fast Fourier Transformation -up to 536 Mio. FFT lines	S
Peak identification	Automatically identify signal peaks in the frequency spectrum	S
Spectrogram	Show a live Spectrogram of the FFTs of the ongoing measurements	S
Fourier boundaries	Limit live FFT-calculation to certain time ranges of the time data	S
Signal trigger	Trigger your measurement with the vel., disp., or accel. signal	S
External trigger	Trigger your measurement with an external TTL signal (3.3 V)	0
Multiple traces	Record and recall multiple traces of the vel./disp./accel. time data	S
Arbitrary signal generator	Import file formats: .csv ASCII- or .wav audio files Pre-defined signals: sin, rectangle, chirp, random, ...	0

Maintenance Specials

Warranty

Warranty	12 months	S
Warranty extension	Extension of standard warranty to 24 months	0

Software Updates

Software maintenance	Free software updates within warranty period	S
Extended maintenance	Additional extension of software updates by 12+ months	0

Hardware Maintenance

Hardware Maintenance	Free hardware maintenance within warranty period	S
Extended maintenance	Additional extension of hardware maintenance by 12+ months	0
Recalibration & cleaning	Check, cleaning & realignment of optical parts, check of laser output power, perform factory calibration	0

Laser product label

DO NOT STARE INTO BEAM Class 2 Laser Product

Laser CLASS 1: invisible, $\lambda = 1550 \text{ nm}$, output power: < 10 mW

Laser CLASS 2: visible, green laser beam, $\lambda = 510\text{-}530 \text{ nm}$,
output power: < 1 mW

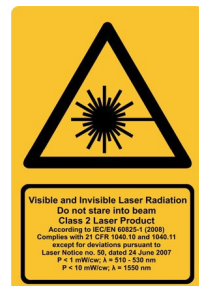

optomet.

LASER VIBROMETRY



Optomet GmbH

Pfungstädter Straße 92
64297 Darmstadt
Germany

Phone: +49 6151-38432-0
Mail: sales@optomet.de
www.optomet.com

